

- ^{ぶんどき}分度器の中心を点アに合わせて次の角度をかきましょう。

1 65°

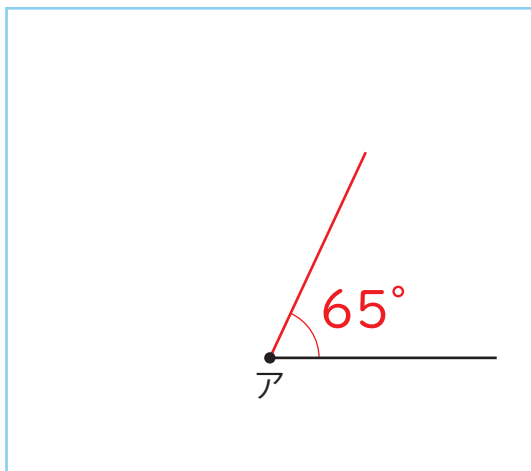

2 135°

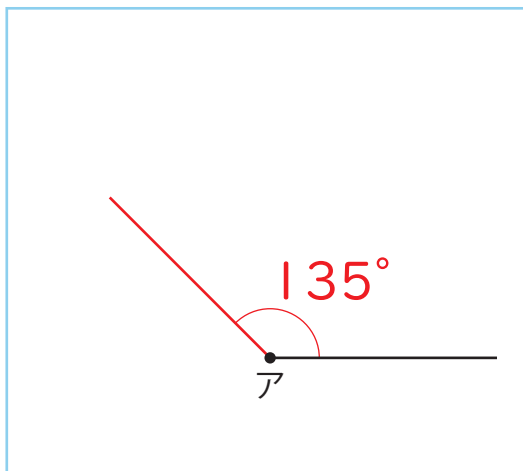

3 175°

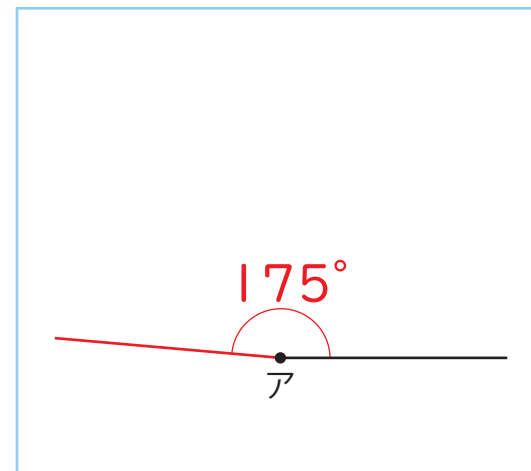

4 140°

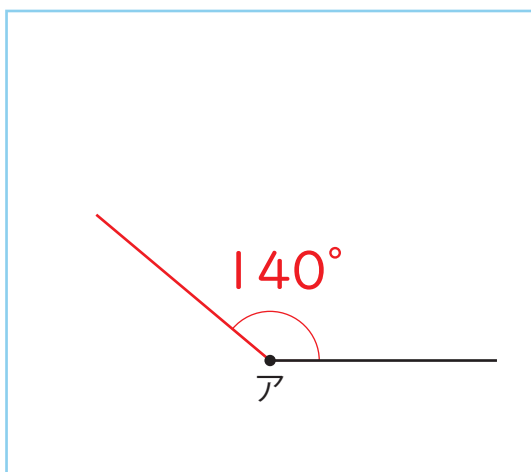

5 25°

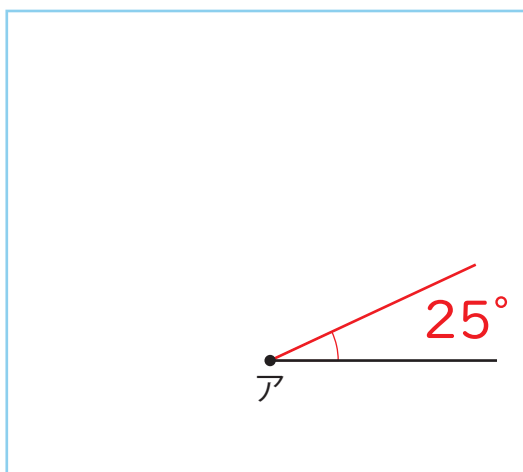

6 120°

